

TView Gold

User's Guide

Rev. 8/01

FCC NOTICE

This equipment has been tested and found to comply with the limits for a Class B digital device, pursuant to Part 15 of the FCC Rules. These limits are designed to provide reasonable protection against harmful interference in a residential installation. This equipment generates, uses and can radiate radio frequency energy, and if not installed and used in accordance with the installation manual, may cause harmful interference to radio communications. However, there is no guarantee that interference will not occur in a particular installation. If this equipment does cause harmful interference to radio or television reception, which can be determined by turning the equipment on and off, the user is encouraged to try to correct the interference by one or more of the following measures:

- This unit was tested with shielded cable. Therefore, for continued compliance, use the shielded cables provided with the unit.
- Re-orient or relocate the unit or receiving antenna.
- Increase the separation between the computer/converter and television.
- Connect the equipment to an outlet on a circuit different from that to which the receiver is connected.
- Consult the dealer or an experienced radio/TV technician for help.

You may find the following booklet helpful:

How to Identify and Resolve Radio-TV Interference Problems (stock number 004-000-000345-4)

To order the booklet, write to:

The U.S. Government Printing Office
Washington D.C. 20402

COPYRIGHT

This document and the software described in it are copyrighted under United States Copyright Laws. No part of this document or software may be copied without prior written consent from FOCUS Enhancements, Inc. except in the normal use of the software as described in this documentation. All printed circuits, their physical implementation on printed circuit boards, including the LCA program's configuration bit streams, and associated software are copyrighted with all rights reserved. Under the copyright laws, the printed circuit board, or the software programs provided may not be copied in whole or part, without written consent of FOCUS Enhancements, Inc., except in the normal use of the software programs to make a backup copy. This exception does not allow copies to be made for others, whether sold or not, but all of the material may be sold, given, or loaned to another person. Under the law, copying includes translating into another language or format.

Microsoft Windows, Windows 95, 98, 2000, ME, NT and Microsoft are trademarks of Microsoft Corporation. All other products named are trademarks of their respective manufacturers.

©2001 FOCUS Enhancements, Inc. All Rights Reserved

Table of Contents

| | |
|---|-----------|
| FCC NOTICE | ii |
| COPYRIGHT | iii |
| TABLE OF CONTENTS | IV |
| About the User's Guide | 1 |
| Notation Conventions | 2 |
| Ordering Information | 2 |
| INTRODUCTION | 3 |
| Features | 3 |
| Modes of Operation | 4 |
| Suggested Uses for the TView Gold | 5 |
| Specifications | 6 |
| HARDWARE INSTALLATION | 7 |
| System Requirements | 7 |
| Pre-Installation Procedures | 8 |
| Connecting the TView Gold to an IBM PC or Macintosh Computer | 9 |
| Connecting the TView Gold to a Television | 15 |
| Connecting to the Television Using an RF Modulator | 19 |
| Connecting the TView Gold to a VCR | 20 |
| SOFTWARE INSTALLATION | 23 |
| Windows Installation | 23 |
| TV Fonts | 25 |

| | |
|---|-----------|
| Macintosh Installation | 26 |
| IMAGE CONTROL | 27 |
| Overview | 27 |
| On-Screen Display | 28 |
| Using the Remote Control | 29 |
| Configuring Your PC or Laptop Video Output | 32 |
| Changing Screen Resolutions | 32 |
| TUNING YOUR TELEVISION | 35 |
| Using Your Television's Video Settings | 35 |
| TROUBLESHOOTING | 37 |
| Returning a Damaged or Failed TView Gold Unit | 39 |

About the User's Guide

The TView Gold User's Guide is designed to help you to quickly and easily connect the hardware and install the software for this product. The guide is divided into the following chapters:

Chapter 1: Introduction: *which describes the key features and functionality of the product and some of its many uses. The chapter also discusses the notation conventions used in the guide.*

Chapter 2: Installing the Hardware: *which describes the information you should know before installing and connecting the TView Gold hardware, and the steps required to perform the installation.*

Chapter 3: Installing the Software: *which describes the TView universal installer software, the steps required to perform the installation, what you get with the software, and how to use the applications.*

Chapter 4: Image Control: *describes the location and functions of the control buttons on the TView Gold Unit, the buttons on the remote control, and how to use the remote to adjust the image. It also describes the steps involved in configuring your PC or laptop video output.*

Chapter 5: Tuning Your Television: *this chapter describes the methods you can use to tune the image on your television.*

Chapter 6: Troubleshooting: *describes possible problems that you might encounter and ways to solve them.*

Notation Conventions

This user's guide uses the following conventions to specify certain types of information.



Warns you about potential problems and hazards during the installation or use of the product. Read these warnings carefully, and be sure you understand how they relate to the installation procedures before proceeding.

Note: Points out important or useful information.

Ordering Information

To get information on the reseller nearest to you or to order replacement parts, contact one of the following:

Worldwide headquarters
1370 Dell Avenue
Campbell, CA 95008
408-866-8300
800-338-3348 (U.S. Only)

On-line
<http://www.FOCUSinfo.com>
e-mail: info@FOCUSinfo.com

Chapter 1

Introduction

The TView Gold converts the video output from your computer into video that can be displayed on a television or recorded to a VCR. . The result is a high quality, flicker-free television display from your computer.

Features

The TView Gold includes the following features:

- Screen position controls
- Easy plug-and-play installation for any computer with a VGA output and the following platforms: Windows95™, 98, 2000, ME, NT and MacOS™
- Compatibility with any size television monitor (NTSC/PAL) with an RCA (composite) or S-Video input connector.
- Support for screen resolutions up to 1600x1280
- Support for 24-bit color
- 2x image zoom with pan control
- 9 Position area Zoom control
- Highlight, Spotlight, and Pointer Controls
- 2 Dimensional Flicker reduction filter with six preset modes
- Brightness, Sharpness, Contrast adjustments
- Kensington® Microsaver Lock Port
- Infrared remote control

- Electronic Marker™ Software

Modes of Operation

The TView Gold has ability to operate in three separate modes:

1. Presentation Mode: Display the same image on your computer VGA (or compatible) monitor and television simultaneously.

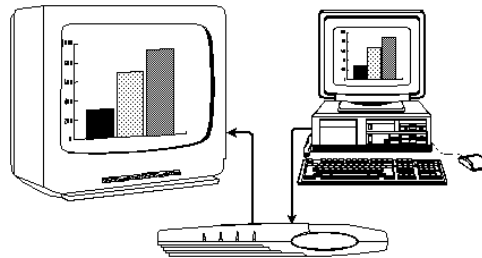

Figure 1-1: Presentation Mode

2. Television Only Mode: Use the television as your only display.

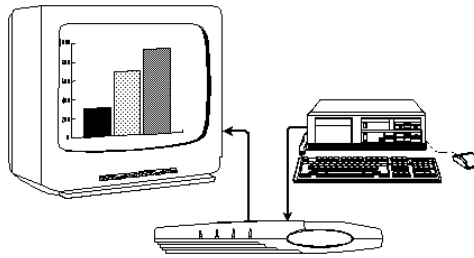

Figure 1-2: Television Only Mode

3. Video Record Mode: Record your video image directly to videotape.

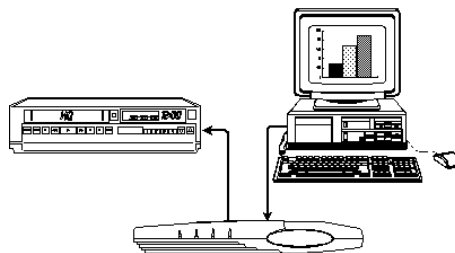

Figure 1-3: Video Record Mode

Suggested Uses for the TView Gold

The TView Gold can be used for many purposes. For example:

- Bring sales or other multimedia presentations from a laptop to a large TV
- Create training tapes or outfit a training room
- Demonstrate a new software package using a large

screen TV

- Project computer games onto a TV screen
- Cruise the Internet on any television
- Conferencing via TV
- E-Mail
- Collaborating with others on computer-based projects

Specifications

Table 1: TView Gold Specifications.

| | |
|-----------------------------------|---|
| Computer Compatibility | <ul style="list-style-type: none"> • Any . Window 95™, 98™, 2000, ME ,NT and MacOS™ 7.1 or higher computer with VGA output |
| Television Compatibility | <ul style="list-style-type: none"> • Works with any size television monitor (NTSC/PAL) with an RCA (composite) or S-Video input connector. For television receivers or televisions without composite or S-Video inputs, an RF Modulator is required (Radio Shack #15-1283) |
| Color Modes and Resolution | <ul style="list-style-type: none"> • Supports up to 16,777,216 colors (24-bit), and up to 1600x1280 |
| Power Supply | <ul style="list-style-type: none"> • Maximum consumption 5 volt DC, 700 MA |
| Unit Weight | <ul style="list-style-type: none"> • 11 ounces (without cables) |
| Unit Dimensions | <ul style="list-style-type: none"> • 8.2" x 3.6" x 1.7" |

Chapter 2

Hardware Installation

This chapter describes the information you should know before installing and connecting the TView Gold hardware, and the steps required to perform the installation.

System Requirements

Before installation, the following are system requirements for the operation of the TView Gold :

IBM (or compatible)

- Personal or multimedia computer with a 486 or higher processor
- Microsoft Windows 95, 98, NT, 2000 or ME
- VGA, SVGA, XGA, SXGA, and UXGA desktop resolution

Macintosh (or compatible)

- Any Macintosh with VGA output (older Mac's may require a DB-15 to HD-15 VGA adapter kit)
- MacOS System Software 7.1 or higher
- VGA, SVGA, XGA, SXGA, and UXGA desktop resolution
- A TV/Monitor, VCR or any video device that can display or record NTSC video

Pre-Installation Procedures

Before installing the hardware, you must unpack and inspect the equipment. This section discusses the steps for unpacking and inspecting the equipment.

Checking the Packing List

Check the packing list that is included in this manual. Compare the list with the equipment you have purchased. Be sure that you have received everything that is on the list. If anything is missing, contact FOCUS Enhancements Customer Service department by calling 1-800-338-3348.

Packing List

Your TView Gold includes the following items:

- TView Gold
- Power adapter 5V DC@ 700mA
- S-Video cable
- Composite video cable or SCART adapter cable (SCART In Europe Only)
- UniViewer monitor cable
- Infrared remote control
- User's guide and Quick Start Guide (on CD ROM)

Inspecting the Equipment

Before installing and connecting the hardware, inspect it for any damage which may have been incurred during shipment. Perform a thorough inspection, looking for dents, scratches, or loose parts. Look for anything that appears unusual or out-of-the ordinary. If any of the equipment is damaged, contact FOCUS Enhancement's Customer Service department by calling 1-800-338-3348.

Connecting the TView Gold to an IBM PC or Macintosh Computer

This section describes the steps to connect your TView Gold to a television or VCR. The following sections describe how to connect to IBM PCs, Macintosh PCs, IBM PC laptops and Notebooks, and Macintosh PowerBook's.

Notes: 1. Before performing the steps to connect the TView Gold to a laptop computer, you must enable the external video connector. This is accomplished by using a particular key sequence (hot key) on the keyboard (for example, FN + F11) or through the BIOS setup program. Refer to your laptop owner's manual to determine how the external video connector is enabled.

2. Not all Macintosh PowerBook computers have a VGA connector for an external monitor. Some PowerBook's require a special cable to output VGA Video. Refer to your PowerBook owner's manual or Apple's web site for more information.

Perform the following steps to connect the TView Gold to a PC or Macintosh Desktop or Laptop:

1. Turn the computer and monitor off.



The computer must be off when connecting the TView Gold. Connecting with the power on could result in static damage to your computer and video equipment.

2. Disconnect the current monitor cable from the "monitor out" port at the rear of the computer.
3. Connect the male DB-15 end of the supplied UniViewer cable to the port at the rear of the TView Gold labeled "Video In."
4. For an IBM PC, compatible and Macintosh, connect the pass-through end of the UniViewer cable to the "monitor out" port at the rear of the computer, the same port from which you disconnected the current monitor cable in step 2.

Note: Steps 5 and 6 facilitate the use of the TView Gold in the Presentation Mode.

5. Connect the male end of your computer's monitor cable to the video pass-through port on the UniViewer cable. This port is located on the UniViewer cable itself, at the end of the cable that is connected to the "Monitor out" port on the computer.
6. Connect the female end of the monitor cable to the monitor.
7. Connect the power adapter to the rear of the TView Gold. Plug the adapter into the nearest wall outlet. The red power LED at the front of the unit will illuminate, indicating the TView Gold is ON.

Is it possible to have a Apple G4 Desktop work with a Focus Enhancements TView Gold in Video Mirroring Mode?

This depends on which model G4 computer (Figure 1) you have as well as what type of Monitor Display you are using. If using a standard Mutisync VGA Monitor or a Apple Studio Display 17 or 21 with any G4 model listed below then there are no issues. Note: See Figure 2 and Figure 3 for Monitor Display Connector.

Figure 1

| | | |
|--------------|------------------|--------------|
| Mac G4 Model | With VGA Monitor | With ADC/DVI |
|--------------|------------------|--------------|

| | | Monitor |
|-----------------|-----|---|
| CI | Yes | N/A |
| .GP Graphics | Yes | *Requires second PCI video Card for video mirroring |
| igabit Ethernet | Yes | *Requires second PCI video Card for video mirroring |
| igital Audio | Yes | *Requires second PCI video Card for video mirroring |
| ube | Yes | *Requires second PCI video Card for video mirroring |
| uicksilver | Yes | *Requires second PCI video Card for video mirroring or optional Nvidia Gforce 3 Twin View card. |

*You can still attach the scan converter to the VGA port but you cannot use Video Mirroring.

Figure 2
VGA

DVI

ADC



Figure 3



Note: for more information regarding models and display types visit Apples web site at <http://docs.info.apple.com/article.html?artnum=25221>

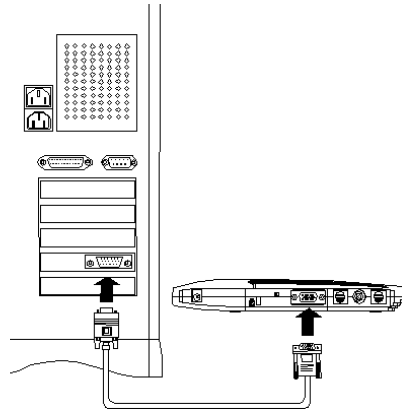

Figure 2-1: Connecting the TView Gold to an IBM or Macintosh PC

Note: Some Mac models also have a ADC or DVI connector for use with some Apple Studio or Cinema Displays. Simply use the VGA to connect the TView Gold. Also note that Video Mirroring may not be available when using both the VGA and ADC/DVI connectors. Consult your computers owner manual for more information on Video Mirroring.

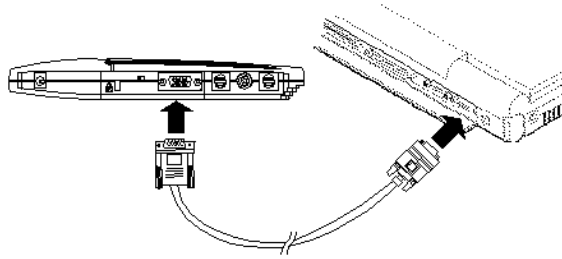

Figure 2-2: Connecting the TView Gold to an IBM or Macintosh Laptop

Note: Use A/C power with a TView Gold and a laptop. If you are using battery power, your video output may be interrupted to conserve power.

Connecting the TView Gold to a Television

The next step is to connect to the television. (If you are planning to connect to a VCR, see "Connecting to a VCR" below.) There are two possible ways to connect to a television:

- Using a composite video connection
- Using an S-Video connection

Composite Video Connection

Composite video is a connection type used by most televisions, VCRs, laserdisc players, and certain LCD panels.

The connectors on a composite video cable have an RCA-type plug. The plug has a long metal pin projecting from its center and plugs into the composite video in port at the rear of the television.

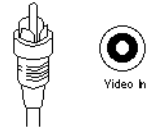

Figure 2-3: Composite Video Connectors

To determine if your television supports composite video, look for a port on your television that matches the composite video out port at the rear of the TView Gold unit.

Note: The composite video port on the television may or may not be labeled "video in."

S-Video Connection

S-Video is a high-quality video connection used by some video cameras and VCRs. The connector on an S-Video cable has a round plug with several small metal pins. It plugs into the S-Video output port at the rear of the TView Gold unit.

Note: The S-Video connection is a newer video standard.

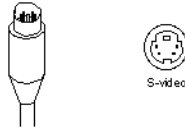

This type connection improves color, clarity, and resolution. It is recommended that if S-Video connection is available it be used.

Figure 2-4: S-Video Connectors

To determine if your television or supports S-Video, look for a port at the rear of the television that matches the S-Video output port at the rear of the TView Gold Unit.

Note: The S-Video port on the television may or may not be labeled "S-Video in."

When you are looking at the television to make these connections, you may see an input labeled ANT IN. This input is used by cable TV companies and uses a different type of video than that used by TView Gold . It is not possible to connect directly to this input. If this is the only input available, and you do not have a VCR, this input can be used with an RF modulator. See below for further information.

To connect the TView Gold unit to your television, perform the following steps:

1. Connect one end of the supplied composite video cable or S-Video cable to the port at the rear of the TView Gold

labeled either "Comp Video" or "S-Video."

2. Connect the other end of the composite cable or S-Video cable to the Comp Video in or S-Video in port at the rear of the television.
3. Turn the television on.
4. Turn the TView Gold on.
5. Turn your computer on. If the cables have been connected correctly, the image from the computer monitor should now appear on the television screen.

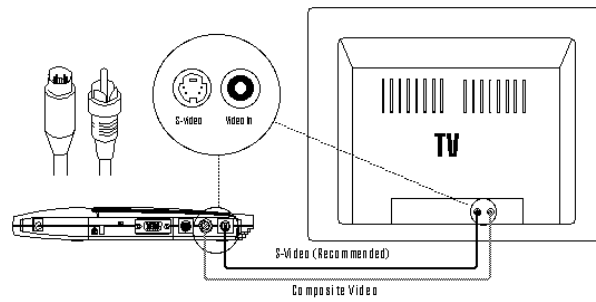

Figure 2-5: Connecting TView Gold to the Television

Note: Because the port may not be labeled, you will need to match the port to the connector you are using.

Connecting to the Television Using an RF Modulator

If you do not have a television with composite video or S-Video, you will need a special adapter called an RF Modulator. This device converts the Composite Video signal from the TView Gold unit to an antenna signal. The RF Modulator is not supplied. FOCUS Enhancements Technical Support recommends using the Radio Shack RF Modulator (Radio Shack part number 15-1283).

Note: When using an RF Modulator, the TV may have to be set to a particular channel (for instance, 3 or 4) to accept the TView Gold 's video. Or, in some cases, you may have to specify input using the TV's on-screen programming feature. If you are unsure about how to set your television to accept external video through the Antenna In, refer to the television owner's manual.

To connect the TView Gold to your television using the RF Modulator, perform the following steps:

1. Connect the RF Modulator to the coaxial input at the rear

of the television.

2. Connect one end of the composite video cable to the port labeled "Comp Video" at the rear of the TView Gold unit.
3. Connect the other end of the composite video cable to the RF Modulator's Composite Input at the rear of the television.
4. Plug RF modulator into wall outlet or surge protector
5. Turn your computer on.
6. Turn the TView Gold on.
7. Turn the television on. If the cables have been connected correctly, the image from the computer monitor should now appear on the television screen.

Connecting the TView Gold to a VCR

In certain configurations, the video will be run through a VCR. Therefore the unit must be connected to the VCR. By connecting the TView Gold unit you will also be able to record the computer screen to videotape.

To connect your TView Gold to a VCR, perform the following steps:

1. Connect one end of the supplied composite video cable or S-Video cable to the port at the rear of the TView Gold labeled either "Comp Video" or "S-Video".
2. Connect the other end of the composite cable or S-Video

cable to the port at the rear of your VCR labeled "Video Input" or "AUX-IN," "AV-IN," or "S-VIDEO IN."

3. Turn on the VCR.
4. Turn on your television and tune it to channel 3 or 4.
5. Turn the TView Gold unit on.
6. Turn the computer on.
7. Find a button on the front of the VCR called "Line," "TV/Video," "Video Input," or something similar. Press the button. If the cables have been connected correctly, the image from the computer monitor should now appear on the television screen.

Note If your VCR does not have a button specifying video-in, use your VCR's remote control to find an on-screen programming system. Using the programming system, set the VCR to receive external video. If you are unsure about how to do this, refer to the VCR owner's manual.

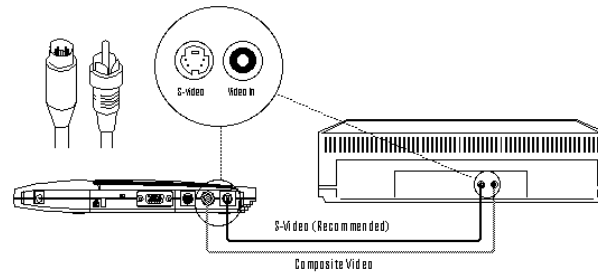

Figure 2-6: Connecting the TView Gold to a VCR

Chapter 3

Software Installation

Your TView Gold is completely plug and play. The unit will work even if this software is not installed.

Windows Installation

What's on the CD?

The CD allows you to install three utilities:

- TView Fonts: The TView font files are installed in the Windows System subdirectory. The TV fonts that are installed are easy-to-read fonts, recommended if you are using small type fonts when displaying on TV.
- Product Manual
- Electronic Marker

Windows 95, 98, 2000, ME & NT Installation

To install the software on your Windows system, perform the following steps:

1. Insert the TView Gold CD ROM in your CD drive.
2. Double-click on the My Computer icon.
3. Double-click on the A drive.

Note: In this case, A represents the letter of your diskette drive. Use whichever letter has been assigned to the floppy drive on your system.

4. Double-click on "pc_disk."
5. Double-click on the "setup" icon.
6. Follow the setup program instructions.

TV Fonts

The TV fonts included with this software are large and easy to read. They are recommended if your system fonts are small type fonts.

Using the TV Fonts in Windows 95, 98, 2000, ME & NT

To select the TV fonts for your Windows 95, 98, 2000, NT & ME system, perform the following steps:

1. Left click on the START button.
2. Select "Settings."
3. From the drop-down menu, select Control Panel.
4. Double-click on "Display." The Display Properties window appears.
5. Select the "Appearance" tab.
6. Click on "Scheme." A drop-down menu with a list of font types appears. Scroll down the list and select "TV."
7. Click "Apply." The text on the screen will now appear in the TV font.

Macintosh Installation

What's on the CD?

The CD installs the following software:

- **Screen Squeeze:** This software is installed in the Apple menu and extensions folder on the system disk. Screen Squeeze is used to underscan the computer video output to allow it to fit onto a television.

To install the software on your Macintosh system, perform the following steps:

1. Insert the TView Gold CD-ROM in the CD ROM drive.
2. Open the Mac_Disk folder on the CD
3. Double-click on the Screen Squeeze icon.
4. Double-click on the Screen Squeeze installer.
5. Select your current system disk from the list of choices.
6. Install onto system drive.
7. Reboot your Macintosh.

Chapter 4

Image Control

This chapter describes the location and functions of the control buttons on the TView Gold Unit, the buttons on the remote control, and how to use the remote to adjust the image. It also describes the steps involved in configuring your desktop or laptop video output.

Overview

If you look at the top of your TView Gold unit, you will notice five buttons. These buttons are used to perform various adjustments to the unit's video output. Access to these functions is also available through the infrared remote, which is discussed later in this chapter. See Figure 4-1 below for the location of the screen controls.

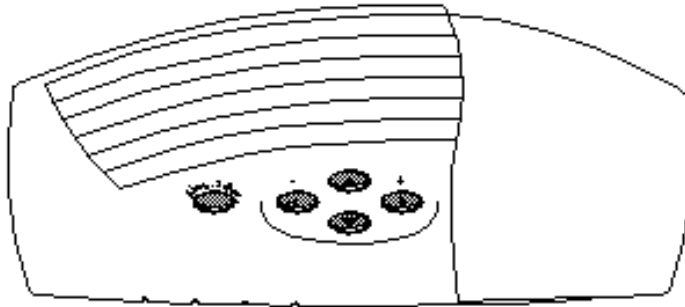

Figure 4-1: TView Gold Screen Controls

The Menu/Select button is used to access the on-screen image control menu on the TV. It is also used to select specific functions and to exit the on-screen menus. The up, down, right and left buttons are used to scroll through the menus and to adjust each of the functions.

On-Screen Display

Main Menu

When you press the Menu/Select button for the first time, the Main Menu appears on the screen. If you want to exit the Main Menu, press the Menu/Select button again.

The Main Menu icons open the menus for the following functions:

- TV Setup
- Computer Setup
- Picture Setup
- Reset

Using the Setup Menus

The TView Gold comes with all of its functions preset. You are able, however, to readjust all of these functions. If you like, you may reset the TView Gold back to its original defaults by entering the Reset menu and either choosing to reset to user settings or to factory default.

Using the Remote Control

The TView Gold comes with a remote control that can be used to adjust many aspects of the computer image on the television. See the figure below. Refer to the previous pages for information about how to use the on-screen menus.









| | | |
|---|---|---|
|  |  |  |
|  |  |  |
|  |  |  |
| Highlight | | Zoom |
| Spotlight | Area | Pointer |
| Sharp | Bright | Contrast |
| Freeze | Position | Sizing |
| Menu | Color | Save |

Figure 4-3: TView Remote Control Buttons

The buttons on the remote perform the following functions:

- **Up/Down Arrows:** Used to size the screen up or down in sizing mode. It is also used to position the screen vertically on the television screen in Position Mode; to move the Highlight Area, Spotlight Area, or pointer vertically; to control area zoom in Area Zoom Mode and

used to pan the screen in Standard Zoom Mode

- **Left/Right Arrows:** Used to scroll through the on screen menus and to adjust certain functions within the menus. In addition to this these buttons are used to size the screen horizontally when in Sizing Mode; to position the screen horizontally in Position Mode; to move the Highlight Area, Spotlight Area, or pointer horizontally; to control area zoom in Area Zoom Mode and used to pan the screen in Standard Zoom Mode
- **Diagonal Arrows:** Used to move the Highlight Area, Spotlight Area, Pointer. Also used to control the Area Zoom Mode.
- **Highlight Button:** Used to turn on the Highlight Mode. In Highlight mode a selected area of the screen will remain bright and the remainder of the screen will be darkened slightly. By pressing the Highlight Button a second and third time you can change the size and shape of the highlight window.
- **Spotlight Button:** Used to turn on the Spotlight Mode. In Spotlight Mode a selected area of the screen will remain bright while the remainder of the screen will be completely black. By pressing the Spotlight Button a second and third time you can change the size and shape of the spotlight window.
- **Sharpness Button:** Used to toggle into the Sharpness Adjustment Mode. Once the Sharpness Button has been pressed, the Sharpness Menu will appear on the television screen. Use the arrow keys to select from the six preset sharpness modes. The modes are listed in order from least sharp too sharpest.
- **Freeze Button:** Freezes the current image on the screen.
- **Menu Button:** Used to access the pop-up menu on the monitor.
- **Area Button:** Used to toggle in and out of the Area Zoom

Mode. While in Area Zoom Mode, you can use the nine arrow keys to quickly pan to a region on the screen.

- **Bright Button:** Used to toggle in and out of the Brightness Adjustment Mode. While in Brightness Adjustment Mode; use the arrow keys to set the desired level of brightness.
- **Position Button:** Used to toggle in and out of the Position Mode. While in Position Mode use the arrow keys to position the computer image on the television screen.
- **Color Button:** Used to toggle in and out of Color Adjustment Mode. While in Color Adjustment Mode use the arrow keys to select the desired color level.
- **Zoom Button:** Used to toggle in and out of the Standard Zoom Mode. While in Zoom Mode use the arrow keys to pan across, or up and down on the screen.
- **Pointer Button:** Used to toggle in and out of the Pointer Mode. While in Pointer Mode you can use the arrow keys to direct the pointer on the screen. Pressing the Pointer Button a second time will change the color of the pointer.
- **Contrast Button:** Used to toggle in and out of the Contrast Adjustment Mode. While in Contrast Adjustment Mode; use the arrow keys to select the desired level of contrast.
- **Sizing Button:** Used to toggle in and out of the Screen Sizing Mode. While in Screen Sizing Mode, use the arrow keys to size the computer image to fit perfectly on your television.
- **Save Button:** Used to save current settings.

Configuring Your PC or Laptop Video Output

Once you have used the on-screen menu to maximize the image, you may want to configure your PC or Macintosh computer.

Changing Screen Resolutions

Windows 95, 98, 2000, ME & NT

To change screen resolutions perform the following steps:

1. Click on the "Start" button.
2. Choose "Settings" and go to the "Control Panel" submenu.
3. Double-click on the "Display" icon.
4. Click on the "Settings" tab.
5. Click on "Change Display Type" or "Advanced Properties."
6. Click on Monitor Type "Change."
7. **IMPORTANT:** Click on "APPLY" first, and then "OK."

Macintosh

To change screen resolutions, perform the following steps:

1. Select "Monitors and Sound" from the control panel.
2. In the resolution area of the monitors window, use the "Show" pull down menu.
3. Select "Show All."
4. Select the desired resolution.

Note: If you select a resolution not supported by the internal LCD, the laptop screen is automatically disabled or will need to be manually disabled.

Configuring the Macintosh Monitor Mode

Most Macintosh PowerBook's allow you to configure the external monitor in two ways:

- **Mirror Mode** - The external monitor reflects whatever appears on the PowerBook screen.
- **Dual Monitor Mode** - The external monitor increases the size of the workspace, allowing you to drag windows or applications from one monitor to another.

Note: Newer PowerBook's such as the 2400s and 3400s do not support dual monitor mode. When the TView Gold is connected to these models, it defaults to external monitor mode, and the PowerBook's internal screen is turned off.

When the TView Gold is connected to the PowerBook, and the PowerBook is initially turned on, it defaults to the dual monitor mode. To ensure that the PowerBook recognizes the second monitor, select "Monitors" from the control panel. If two monitors are recognized, you will see two monitor icons.

To activate the Mirroring Mode, perform the following steps:

1. Select "Monitors and Sound" from the control panel.
2. In the resolution area of the "Monitors and Sound" window, use the "Show" pull down menu.
3. Select "Simulscan."
4. Select the resolution with the word "Simulscan" in parentheses.

Chapter 5

Tuning Your Television

This chapter describes the methods you can use to tune the image on your television.

Using Your Television's Video Settings

Picture quality varies from television to television. To obtain the clearest and sharpest picture from your television, it is important to spend some time adjusting the television's video settings. The following are some suggestions for tuning the video output you see on the screen.

Note: The items listed below are general tips for all televisions. Most televisions have one or more of the controls listed. However, the results of adjusting these items depend on your specific television.

Note: Depending on the model of the television, the image is adjusted using buttons or on-screen programming. Check your owner's manual to determine how the image is adjusted on your television.

Brightness

The Brightness adjustment on the television adjusts the brightness levels of black areas of the picture. Raise or lower the brightness until the picture appears bright without a "blooming" effect. The sides of the picture should be straight, not curved or bowed.

Color

The color adjustment on the television adjusts the intensity of the colors in the picture. Adjust the color control until the picture is clear and has a minimal amount of "color-bleeding." If the color is turned up too high, the color will be over-saturated.

Sharpness

The Sharpness adjustment on your television adjusts the clarity of the edges around objects for the clearest picture quality. The general rule when adjusting sharpness is to turn it up anywhere from its middle to highest level.

Tint or Hue

The Tint or Hue adjustment on your television adjusts the color of the flesh tones to more Green or red. The most effective way to use this adjustment is to display row or column of colors side-by-side and then adjust them until the color appears correct to you.

Chapter 6

Troubleshooting

This chapter describes possible problems that you might encounter and ways to solve them.

| Problem | Possible Causes/Solutions |
|-------------------------------------|---|
| No video from the TView Gold | <ul style="list-style-type: none"> • Check the connection from the computer's video output port to the monitor in port at the rear of the TView Gold unit. • Check the connection from the comp video out port or S-Video out port to the input on your monitor or VCR. • Ensure that the TV or VCR is ON. • Check the connection from the power supply. Is the TView Gold unit plugged in? Is the red power LED ON? • Ensure that your television or VCR has been configured to accept auxiliary video input. • Ensure that the TView Gold is connected to the appropriate video connector on your TV or VCR. At the TV or VCR end, the cable should be connected to the VIDEO, VIDEO IN, or AUX port. |
| Picture Rolls | <ul style="list-style-type: none"> • Ensure that your secondary monitor and computer monitor size are supported by the |

| | |
|--|--|
| | <p>TView Gold</p> <ul style="list-style-type: none"> • Check the PAL/NTSC switch. If in North America, Central America and Japan see this for NTSC. For Europe and certain other countries see this for PAL. • Check and adjust vertical hold and horizontal hold controls on your TV/monitor. |
| Flicker, or other Distortion on your screen | <ul style="list-style-type: none"> • Use of a RF modulator may cause image quality problems. If at all possible, avoid those devices that convert the TView Gold signal into an antenna signal. |
| Colors are poor quality or non-existent | <ul style="list-style-type: none"> • Adjust the color and contrast controls on your TV. • Adjust the brightness control of the TView Gold . • Use of an RF modulator may cause image quality problems. If at all possible, avoid those devices that convert the TView Gold signal into an antenna signal. |
| TV image overshoots or fails to fill the screen | <ul style="list-style-type: none"> • Use the on-screen control to adjust size and positioning. • Adjust the vertical and horizontal size controls on your TV. |
| Green power LED does not light | <ul style="list-style-type: none"> • Check power connections. • Possible power supply or TView Gold failure. |
| TView Gold | <ul style="list-style-type: none"> • Inspect the TView Gold unit for signs of damage (i.e. broken pins, severed wires, |

| | |
|---|--|
| failure | etc.) |
| TV or PC screens that have rolling waves | <ul style="list-style-type: none"> • Possible bad or wrong power adapter being used. • Try another adapter or verify that you are using the correct one. |

Returning a Damaged or Failed TView Gold Unit

To return a TView Gold unit, follow these steps:

1. Contact FOCUS Enhancements Technical Support at 1-408-370-9963. A representative is available from 9:00 AM to 5:00PM Pacific Standard Time (PST). Explain the nature of the problem and any evidence of damage you may have found. The customer representative will either assist you with the specific problem or give you a Return Materials Authorization Number.

Note: No goods will be accepted for warranty repair or return without an RMA number.

2. Pack the TView Gold carefully. If possible, use the original shipping package. Send the package pre-paid and insured via United Parcel Service (UPS) or US Mail to:

FOCUS Enhancements

TView Gold User's Guide

ATTN: RMA# (*Your RMA Number*)
1370 Dell Avenue
Campbell, CA 95008

FOCUS Enhancements will repair or replace your TView Gold within 5-15 working days. For units not covered under the 3 year warranty, or where the warranty has been voided, a minimum fee of \$90.00 must be paid.